



SHENZHEN ZHUOMAO TECHNOLOGY CO., LTD.

深圳市卓茂科技有限公司



BGA Rework Station ZM-R5860C Instruction Manual

Address: Building A, Donghua Industrial Park, Sanwei, Xixiang, BaoAn, Shenzhen

TEL: 0755-29929955 29929956 FAX: 0755-29929953

Http: //www.szzhuomao.com E-mail: bga29929955@126.com

Contents

A. Preface	2
B. Structures.....	3
C. Specifications	4
D. Operations.....	5
E. Installation.....	12
F. Packing list.....	13

A. Preface

Shenzhen ZhuoMao Hi-tech Co., Ltd. is a high-technology company located in the western district of BaoAn. Thanks to its proximity to the international airport and container terminal, this part of the booming industrial city of Shenzhen is rich in modern business opportunities.

BGA repair turnkey solutions are the heart of ZhuoMao activities. A strong R&D team supports a dynamic workforce of over fifty people. A well established sales network and after-sales service has built ZhuoMao a strong reputation in China among high profile customers.

The main products of ZhuoMao are BGA Rework Station and some other devices (BGA Mounting, BGA Reballing Machine, and BGA Soldering Machine), BGA Testing Machine (main board testing, video card testing, digital camera testing, and mobile chip testing)

Devoted to put in practice the motto “Specialized, Innovative and Dedicated”, the company is focused on its customer’s satisfaction and has set up a network of local offices to tailor its offer to an expanding market.

Developing new solutions to help customers tackle issues always more diverse and complex keeps ZhuoMao engineering teams to the forefront of the technology and rewards its products with the most prestigious awards and recognition in China and abroad.

Because ZhuoMao understands BGA repair is a critical activity needing speed, accuracy and user-friendliness, its machines are designed for you to

REGAIN SATISFACTION.

B. Structures

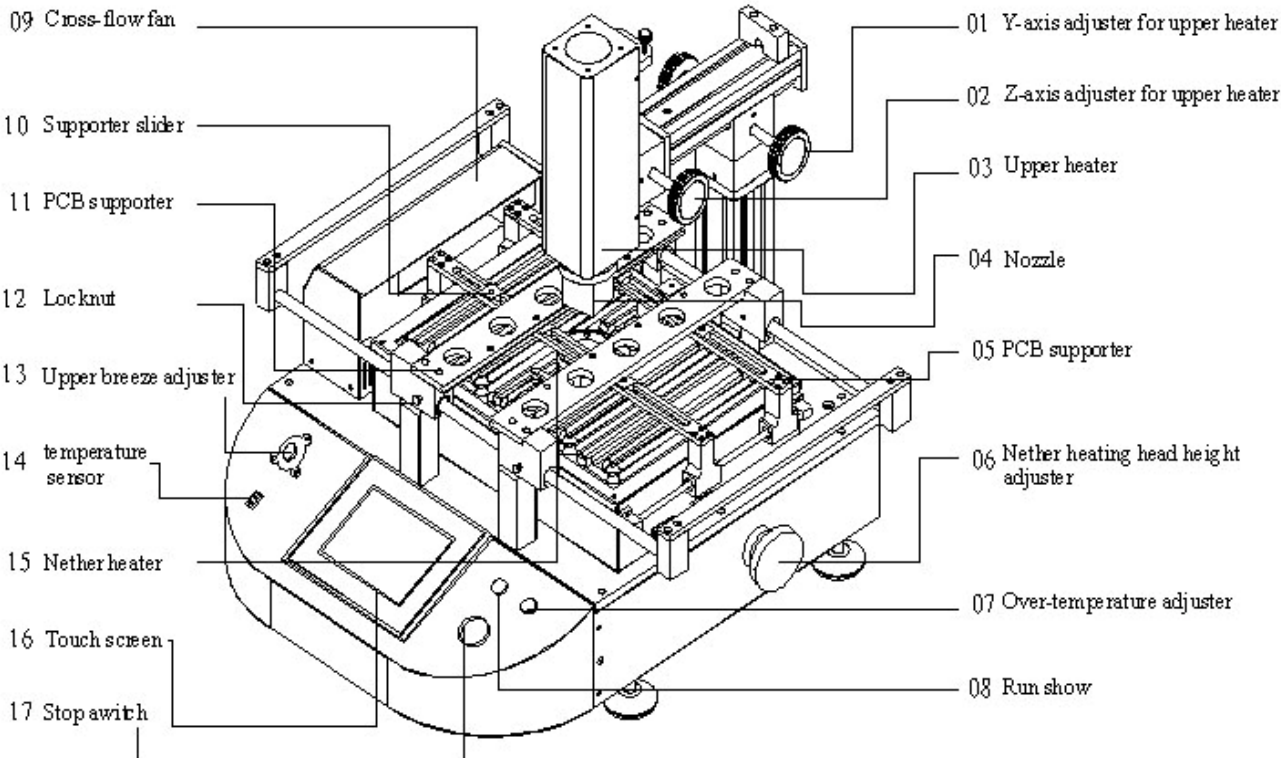

C. Specifications

Specifications	Description
Power supply	Single phase AC220V \pm 10% 50/60Hz
Total power	4.8KW
Top Heater	Hot Air: 0.8K W
Bottom Heater	Hot Air: 1.2KW
IR	Infrared plates: 2.7K W others: 0.1KW
Temperature control	Imported K-type thermocouple (Closed Loop) Heating independent, the precision is \pm 3-5°C
Electric material:	PLC programmable controller + Large-screen TFT Touch Screen+high precision intelligent temperature control module
PCB size	Max: 410x370 mm Min: 22x22 mm
Positioning	V-type PCB clamping 10~20 μ m X-Y table adjust.
Power required	Single Phase AC 220 V (\pm 10%) 50 Hz 5.2 kW
Machine dimensions	L630mm \times W650mm \times H690mm
Weight	40 kg
color	black

D. Operations

1. Set the program.

a. Turn on the electric power supply of the whole machine. The following image will appear on the touch-screen. (The original password is 8888)



b. Click “Ent”.

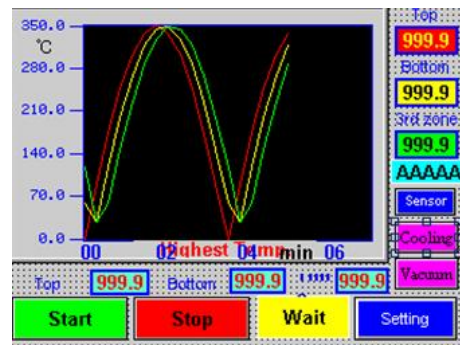

c. Click “Setting”, and then “Temp. setting”.

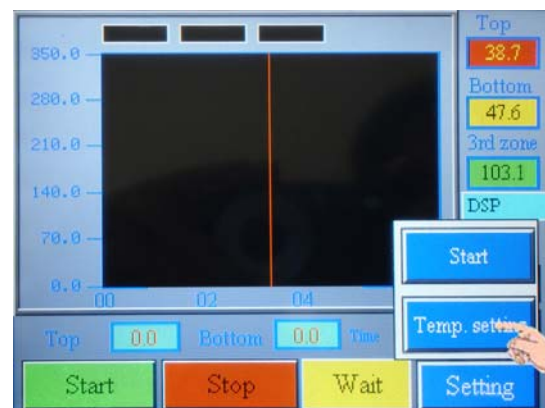
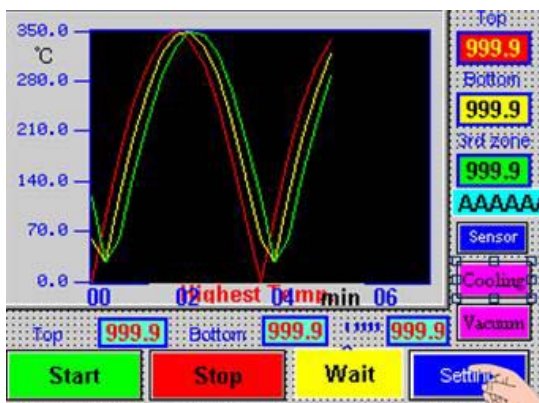

d. Input the proper temperature parameters.

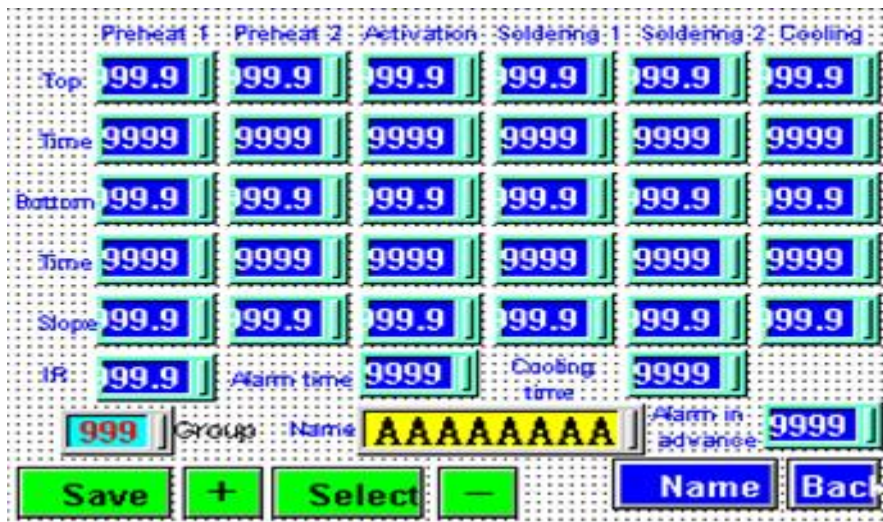

Introduction of the interface (take the above one for example):

Preheat: The temperature of upper and lower heater rises from room temperature to 165°C in 30s at a speed of 3°C/s (the slope).

Keep warm: The temperature of upper and lower heater rises 165°C to 195°C in 30s at a speed of 3°C/s (the slope).

Calective: The temperature of upper and lower heater rises 195°C to 225°C in 30s at a speed of 3°C/s (the slope).

Jointing: The temperature of upper heater rises 225°C to 245°C in 45s at a speed of 3°C/s (the slope).

The temperature of lower heater rises 215°C to 230°C in 45s at a speed of 3°C/s (the slope).

And so forth.....

Alarm time: the time of the alarming.

Alarm in advance: the time between finishing the heating process and starting alarming.

Cool time: the time the cross-flow fan works.

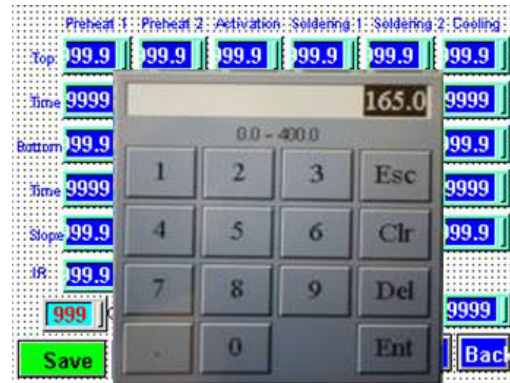
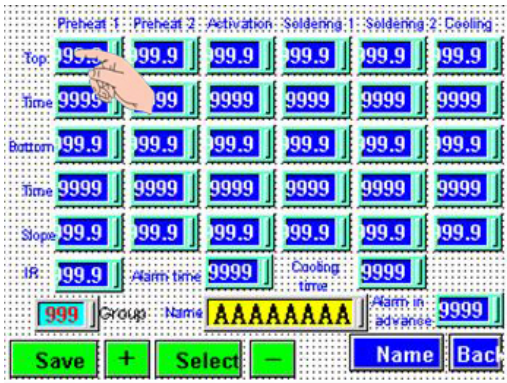

The following are the temperatures for reference

Lead BGA temperature curve welding

- | | | | | | | | | | | | | | | | | | | | | | | | | | | | | | | | |
|---|---------|--------|-------|---------|--------|-------|---------|--------|-------|---------|--------|-------|---------|--------|-------|---|---------|--------|-------|---------|--------|-------|---------|--------|--------|---------|--------|-------|---------|--------|-------|
| <p>1. Upper temperature curve adjustment, nozzle 41*41. Press SET to adjust.</p> <table border="0"> <tr><td>r1:3.00</td><td>L1:160</td><td>d1:30</td></tr> <tr><td>r2:3.00</td><td>L2:185</td><td>d2:30</td></tr> <tr><td>r3:3.00</td><td>L3:230</td><td>d3:45</td></tr> <tr><td>r4:3.00</td><td>L4:240</td><td>d4:25</td></tr> <tr><td>r5:3.00</td><td>L5:225</td><td>d5:25</td></tr> </table> | r1:3.00 | L1:160 | d1:30 | r2:3.00 | L2:185 | d2:30 | r3:3.00 | L3:230 | d3:45 | r4:3.00 | L4:240 | d4:25 | r5:3.00 | L5:225 | d5:25 | <p>2. Upper temperature curve adjustment, nozzle 38*38. Press SET to adjust.</p> <table border="0"> <tr><td>r1:3.00</td><td>L1:160</td><td>d1:30</td></tr> <tr><td>r2:3.00</td><td>L2:185</td><td>d2:30</td></tr> <tr><td>r3:3.00</td><td>L3:225</td><td>d3:45</td></tr> <tr><td>r4:3.00</td><td>L4:240</td><td>d4:25</td></tr> <tr><td>r5:3.00</td><td>L5:225</td><td>d5:25</td></tr> </table> | r1:3.00 | L1:160 | d1:30 | r2:3.00 | L2:185 | d2:30 | r3:3.00 | L3:225 | d3:45 | r4:3.00 | L4:240 | d4:25 | r5:3.00 | L5:225 | d5:25 |
| r1:3.00 | L1:160 | d1:30 | | | | | | | | | | | | | | | | | | | | | | | | | | | | | |
| r2:3.00 | L2:185 | d2:30 | | | | | | | | | | | | | | | | | | | | | | | | | | | | | |
| r3:3.00 | L3:230 | d3:45 | | | | | | | | | | | | | | | | | | | | | | | | | | | | | |
| r4:3.00 | L4:240 | d4:25 | | | | | | | | | | | | | | | | | | | | | | | | | | | | | |
| r5:3.00 | L5:225 | d5:25 | | | | | | | | | | | | | | | | | | | | | | | | | | | | | |
| r1:3.00 | L1:160 | d1:30 | | | | | | | | | | | | | | | | | | | | | | | | | | | | | |
| r2:3.00 | L2:185 | d2:30 | | | | | | | | | | | | | | | | | | | | | | | | | | | | | |
| r3:3.00 | L3:225 | d3:45 | | | | | | | | | | | | | | | | | | | | | | | | | | | | | |
| r4:3.00 | L4:240 | d4:25 | | | | | | | | | | | | | | | | | | | | | | | | | | | | | |
| r5:3.00 | L5:225 | d5:25 | | | | | | | | | | | | | | | | | | | | | | | | | | | | | |
| <p>3. Upper temperature curve adjustment, nozzle 31*31. Press SET to adjust.</p> <table border="0"> <tr><td>r1:3.00</td><td>L1:160</td><td>d1:30</td></tr> <tr><td>r2:3.00</td><td>L2:185</td><td>d2:30</td></tr> <tr><td>r3:3.00</td><td>L3:210</td><td>d3:45</td></tr> <tr><td>r4:3.00</td><td>L4:225</td><td>d4:20</td></tr> <tr><td>r5:3.00</td><td>L5:205</td><td>d5:25</td></tr> </table> | r1:3.00 | L1:160 | d1:30 | r2:3.00 | L2:185 | d2:30 | r3:3.00 | L3:210 | d3:45 | r4:3.00 | L4:225 | d4:20 | r5:3.00 | L5:205 | d5:25 | <p>4. Third temperature zone adjustment. Press SET for 5 seconds to adjust.</p> <table border="0"> <tr><td>r1:2.00</td><td>L1:135</td><td>d1:30</td></tr> <tr><td>r2:2.00</td><td>L2:165</td><td>d2:45</td></tr> <tr><td>r3:2.00</td><td>L3:185</td><td>d3:240</td></tr> </table> | r1:2.00 | L1:135 | d1:30 | r2:2.00 | L2:165 | d2:45 | r3:2.00 | L3:185 | d3:240 | | | | | | |
| r1:3.00 | L1:160 | d1:30 | | | | | | | | | | | | | | | | | | | | | | | | | | | | | |
| r2:3.00 | L2:185 | d2:30 | | | | | | | | | | | | | | | | | | | | | | | | | | | | | |
| r3:3.00 | L3:210 | d3:45 | | | | | | | | | | | | | | | | | | | | | | | | | | | | | |
| r4:3.00 | L4:225 | d4:20 | | | | | | | | | | | | | | | | | | | | | | | | | | | | | |
| r5:3.00 | L5:205 | d5:25 | | | | | | | | | | | | | | | | | | | | | | | | | | | | | |
| r1:2.00 | L1:135 | d1:30 | | | | | | | | | | | | | | | | | | | | | | | | | | | | | |
| r2:2.00 | L2:165 | d2:45 | | | | | | | | | | | | | | | | | | | | | | | | | | | | | |
| r3:2.00 | L3:185 | d3:240 | | | | | | | | | | | | | | | | | | | | | | | | | | | | | |

Lead-free BGA temperature curve welding

- | | | | | | | | | | | | | | | | | | | | | | | | | | |
|--|---------|--------|-------|---------|--------|-------|---------|--------|-------|---------|--------|-------|--|---------|--------|-------|---------|--------|-------|---------|--------|-------|---------|--------|-------|
| <p>1. Upper temperature curve adjustment, nozzle 41*41. Press SET to adjust.</p> <table border="0"> <tr><td>r1:3.00</td><td>L1:165</td><td>d1:30</td></tr> <tr><td>r2:3.00</td><td>L2:200</td><td>d2:30</td></tr> <tr><td>r3:3.00</td><td>L3:245</td><td>d3:50</td></tr> <tr><td>r4:3.00</td><td>L4:255</td><td>d4:35</td></tr> </table> | r1:3.00 | L1:165 | d1:30 | r2:3.00 | L2:200 | d2:30 | r3:3.00 | L3:245 | d3:50 | r4:3.00 | L4:255 | d4:35 | <p>2. Upper temperature curve adjustment, nozzle 38*38. Press SET to adjust.</p> <table border="0"> <tr><td>r1:3.00</td><td>L1:165</td><td>d1:30</td></tr> <tr><td>r2:3.00</td><td>L2:195</td><td>d2:35</td></tr> <tr><td>r3:3.00</td><td>L3:240</td><td>d3:45</td></tr> <tr><td>r4:3.00</td><td>L4:250</td><td>d4:25</td></tr> </table> | r1:3.00 | L1:165 | d1:30 | r2:3.00 | L2:195 | d2:35 | r3:3.00 | L3:240 | d3:45 | r4:3.00 | L4:250 | d4:25 |
| r1:3.00 | L1:165 | d1:30 | | | | | | | | | | | | | | | | | | | | | | | |
| r2:3.00 | L2:200 | d2:30 | | | | | | | | | | | | | | | | | | | | | | | |
| r3:3.00 | L3:245 | d3:50 | | | | | | | | | | | | | | | | | | | | | | | |
| r4:3.00 | L4:255 | d4:35 | | | | | | | | | | | | | | | | | | | | | | | |
| r1:3.00 | L1:165 | d1:30 | | | | | | | | | | | | | | | | | | | | | | | |
| r2:3.00 | L2:195 | d2:35 | | | | | | | | | | | | | | | | | | | | | | | |
| r3:3.00 | L3:240 | d3:45 | | | | | | | | | | | | | | | | | | | | | | | |
| r4:3.00 | L4:250 | d4:25 | | | | | | | | | | | | | | | | | | | | | | | |

r5:3.00 L5:235 d5:25 r5:3.00 L5:230 d5:25

3. Upper temperature curve adjustment, nozzle 31*31. Press SET to adjust.

r1:3.00 L1:165 d1:30
 r2:3.00 L2:190 d2:30
 r3:3.00 L3:235 d3:45
 r4:3.00 L4:245 d4:20
 r5:3.00 L5:225 d5:25

4. Third temperature zone adjustment. Press SET for 5 seconds to adjust.

r1:2.00 L1:135 d1:30
 r2:2.00 L2:165 d2:45
 r3:2.00 L3:185 d3:40
 r4:2.00 L3:210 d3:240

No.: Click the number before “Group”, input the number you want to name it by.



Name: Click “Name”, the input interface of name will appear, and you can set the name. Click “ENT” to the set interface.

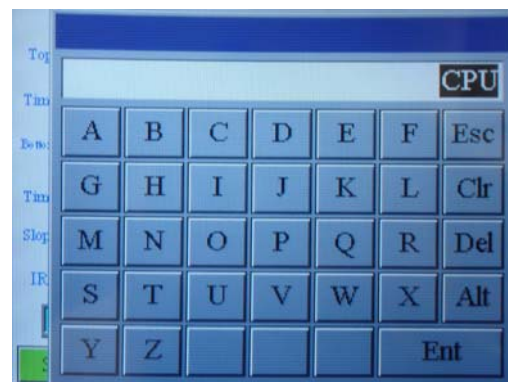
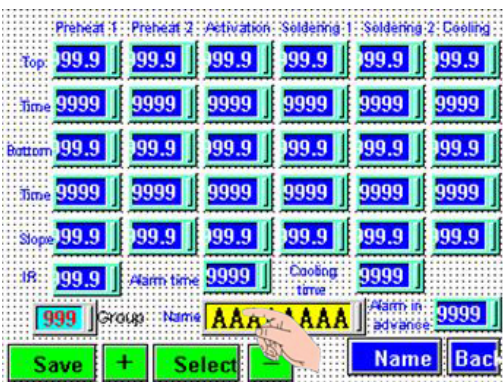

If you want to name with number, you can click “Del” and “Alt”.

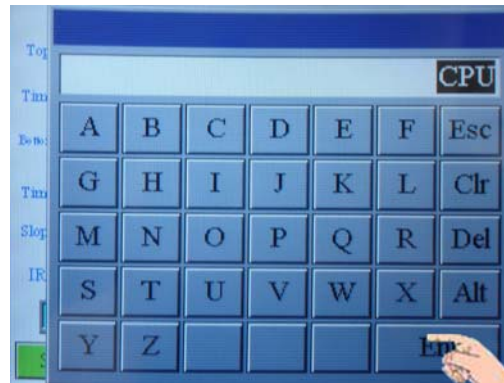
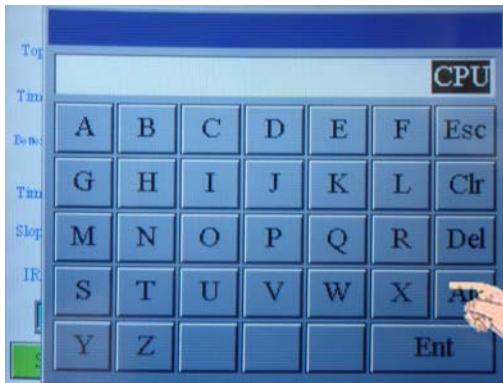

2. Operation

a. Turn on the power supply of the machine, and click “Operation”.

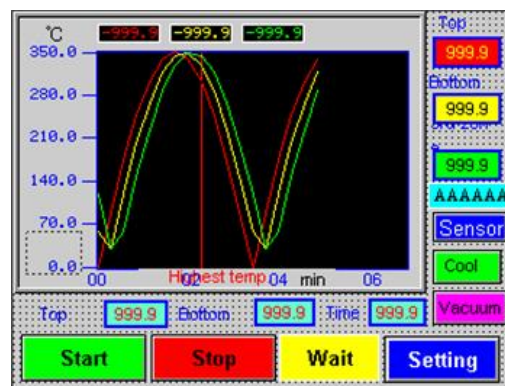

b. Click “Setting” and “Temp. setting”.

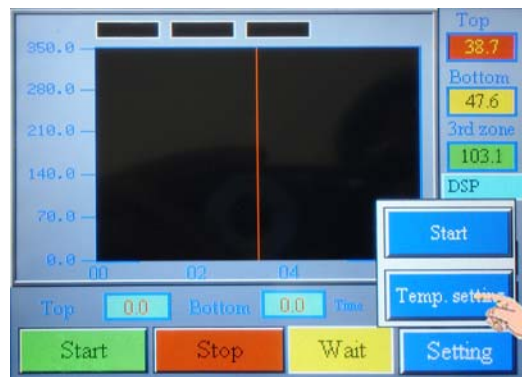
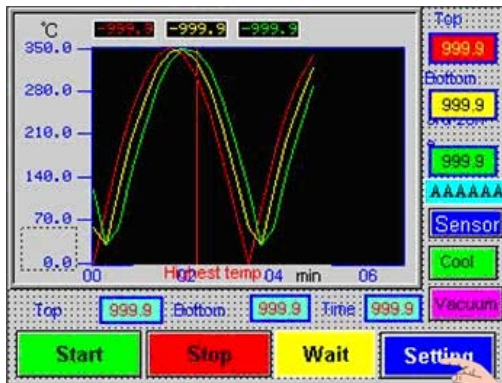

c. Choose the right group of temperature profile.

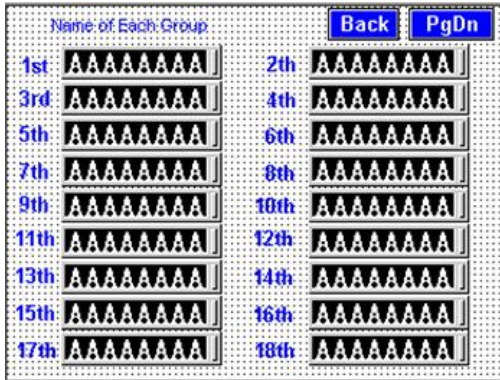

d. If you want to work with the 2nd group, click “DSP” The 2nd group of setting will appear, then click “Back”.

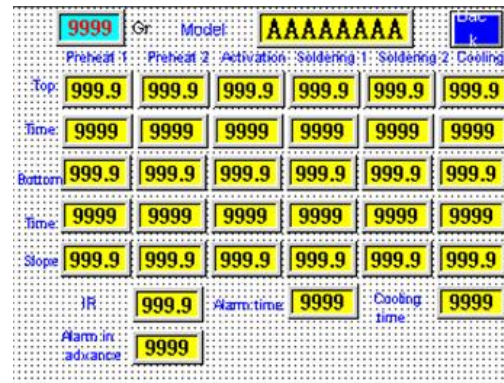

e. Then the following interface will appear on the screen.

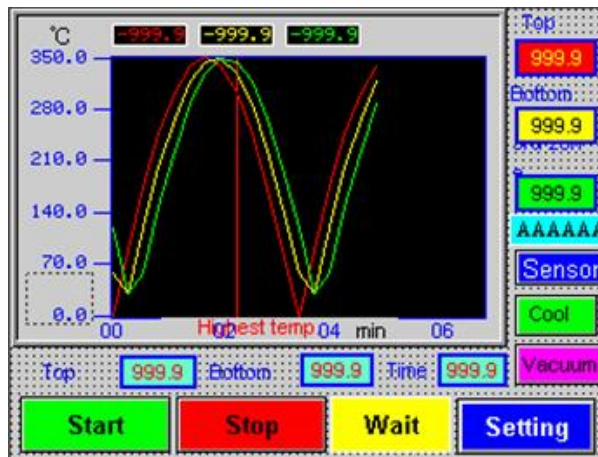

f. Fix the proper PCB and BGA as shown in the picture. Move the heater down to above the BGA, keeping a distance of 3-5mm between the bottom edge of the nozzle and the surface of BGA, as shown in the following picture. When the solder process is finished, there will be an alarming.

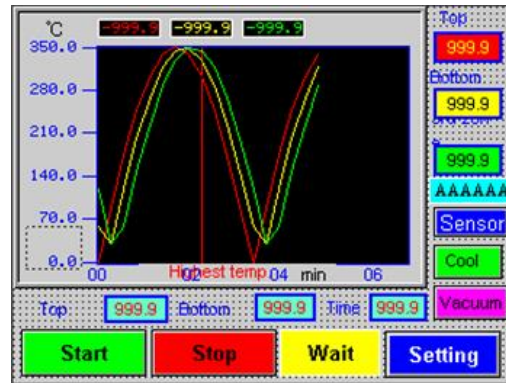

E. Installation

In order to ensure the validity of BGA Rework Station, the installation should meet the following requirements.

1. Away from inflammable and explosives;
2. Away from water and other liquids;
3. Ventilated, dry place;
4. Stable and flat, free from tremor.
5. Less dust;
6. No heavy objects on the controlling box;
7. Not affected by airflow of air conditioner, heater or ventilator.
8. Leave a space of 30cm or more behind the rework station for the upper part to move and rotate.
9. Because the machine is equipped with a touch screen it must be put on the big platform to make sure it will never move from side to side.

F. Packing list

NO.	Item	Specification	Unit	Qty
1	BGA Rework Station	ZM-R5860C	SET	1
2	Vacuum sucker		PCS	2
3	Hot-air nozzle		PCS	5
4	Temperature sensor		PCS	1
5	Supporting screw		PCS	6
6	Instruction manual	ZM-R5860C	Copy	1
7	Fixture		PCS	6
8	Brush		PCS	1

5th、 The use of external measuring galvanic

(1) Function

- 1、 More accurate to measure the actual temperature of the part to be heated during the welding process.
- 2、 It is easy to move, so that it can be convenient to measure the temperature of the different parts of the welded components during the heating process.
- 3、 Calibration role, through appropriate adjustment, it will make the temperature of the welding parts get close to the set temperature as much as possible.

(2) Installation

- 1、 Check the galvanic lines, whether there are disconnected phenomena or not.
- 2、 Insert the galvanic Plug into the "outer galvanic Socket" on the control panel according to the positive and negative mark.
- 3、 After GALVANIC installed correctly, click "DiSP SELE" button on the upper instrument panel, (the button which is used to switch the displaying item), switch to "TIME", the corresponding galvanic current temperature will be displayed in the second line of instrumentation on the "SV" display window.

Stated: "DiSP SELE" is the button to switch the displaying items, when press it, the downstream sequence

of display windows display setting no., output no., the remainder of the number of segments of running, corresponding to Panel "SV", "MV", "TIME "indicator light.

(3) measurement

- 1、PCB board will be installed on the rework station, with the galvanic fixed on the PCB board using foil stickers.
- 2、Adjust the height of the probe; With the probe galvanic head located in the top 1-2mm of the test site (as shown in Figure 12)



Picture 29

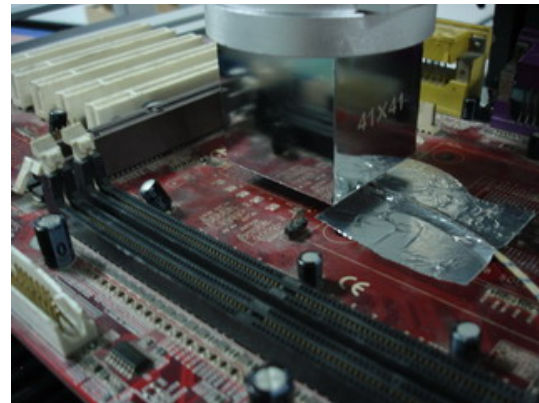

Picture 30

- 3、Adjust the related mechanical adjustment knob, so that the heating part just below the hot-air tube. (as shown in Figure 13)
- 4、Adjust the up and down adjustment knob of the hot-air head to make the distance between the edge of PCB board side and the hot-air head is 3-5mm.
- 5、Implementation of the welding / disordering process, that is to start the process of upper and lower heater.
- 6、Then it will show three curves of the green and red and yellow on the computer monitor screen (picture)
- 7、Curve 1, the actual measurement temperature of the internal galvanic of the top heater (green)
- 8、Curve 2, the actual measurement temperature of the external galvanic curve (red)
- 9、Curve 3, the actual measurement temperature of the internal galvanic of the bottom heater (yellow)

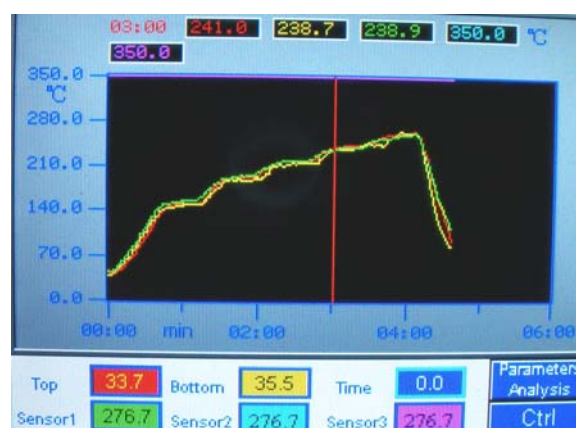

Picture 31

(4) Using the outer galvanic to adjust the temperature curve

Statement: In this operation, it may be due to improper operation to cause the temperature deviation of the device or even lose control, please caution!

Take the upper hot-air tube as an example to make detailed description of adjustment method

- 1、 Set the temperature, the time, the slope and so on parameters of the upper heater
- 2、 Adjustment process proposed to do on a waste circuit board in order to prevent damage to the circuit board and on-board electronic components.
- 3、 Implementation of the above process (3), installed the outer measured galvanic, in which the top of the PCB board just below the hot-air tube.
- 4、 Close the lower part of the heating process, click on "Start" button to start the heating process, which will on the computer monitor screen will be displayed on the upper curve of the measured temperature (green) and external galvanic measuring temperature (red) the two curves
- 5、 Green curves represent the actual measurement of the galvanic temperature curve of the upper heating wire inside, the red curve represents the actual measurement of the galvanic temperature outside. the smaller the gap between the green curve and red curve, the closer between the actual temperature and set temperature of the heating parts, more standard of the upper heating process; On the contrary, the greater the gap between the two curves, the greater the actual temperature deviate from the set temperature, the more non-standard of the upper part during the heating process.
- 6、 If the deviation between the two curves is too much, you should make the appropriate adjustments
- 7、 The specific adjustment method is as follows, because of the impact of the system processes and the environmental, deviations in the objective is inevitable. If the temperature deviation does not affect the normal welding and desordering, non-professionals should avoid the following corrective actions!
 - A If the outer galvanic curve (red) lower than the upper one (green), adjust the internal hairdryer galvanic probe upward;
 - B If the outer galvanic curve (red) higher than the upper one (green), adjust the internal hairdryer galvanic probe downward;
 - C Adjustment must be small, try to control the amplitude of accommodation in 1mm or less;
 - D Repeated several adjustments;
 - E During adjustment process, the heated of galvanic probe is strictly prohibited from contacting with any objects, so as not to affect the accuracy of measuring temperature;
 - F After temperature adjustment, you should fix the probe, to avoid the probe vibration measurement of the temperature of the equipment

G The method of the adjustment applies only to the two parallel curves in a smooth uniform deviation, and it is invalid to the temperature which is from top to bottom jitter free-laws regulating!

H The upper part of the internal galvanic Duct location: Remove the upper heater nozzle, at a distance of 2-3cm at the edge [wind-cone](#) .

I operating the standard procedure to avoid the high-temperature burns!

8、 There is no [booster thermocouple](#) temperature curve on the bottom of the computer screen, so you have to adjust the process of the lower part of the heaters by visual.

9、 fixed the galvanic line with foil stickers on the bottom of PCB board (as opposed to the upper heater set back on the PCB board), so that the probe of the [booster thermocouple](#) is located just 2mm above the mouth of the bottom hot-air nozzle, and adjust the mechanical parts, make the upper hot-air nozzle deviate from the heated parts to avoid cold air affect the temperature of the heated parts.

10、 Set the parameters of the lower heating temperature, while closing the upper part of the heating process, click on "Start" button to start heating

11、 Now you can see "SV" which displayed on the panel of the upper programmable thermostat (also click on the "DISP SELE" button of the upper instrument panel, and switch to the position of the "TIME" indicator light) is the temperature of the external galvanic, with the abbreviation as the outer temperature; And "PV" is the temperature of the internal galvanic, with the abbreviation as the bottom temperature.

12、 The caution is same as the top heater.

13、 The methods of adjustment:

A If the outer temperature is lower than the bottom, you should adjust the lower internal galvanic probe downward.

B If the outer temperature is higher than the bottom; you should adjust the lower internal galvanic probe upward.

6th、 Reballing Process

1. Fixed the BGA chip which need to be reballled on the under plate of the adjustable reballing kit, and then adjust the No-spring slider to fix the chip.

2. Choose the stencil according to the style of chip, then fix the stencil on the top cover of the adjustable reballing kit and lock the four M3 screws, cover the cap. Adjust the four screws of the under plate to fit for the height of the chip.

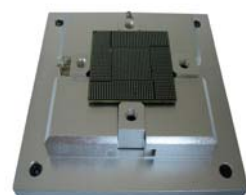

3. Check the alignment of the hole of the stencil and the welding spot of the chip, if it is in misalignment, then remove the cover and adjust the fixed slider until it is in alignment.

4. Lock the fixed slider of the two no-spring slider, take out the BGA chip and wipe a layer of solder paste, fixed the chip on the adjustable rebalancing kit again, cover the cap.

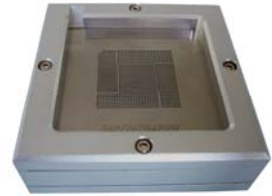

5. Put some solder balls into the kit, clutch and shake it to make all the balls stand on the welding spot, and at the same time, clear the superabundant balls.



6. Put the rebalancing kit on the desk, take out the top cover, and bring out the BGA cheap carefully, and check it whether there are some balls on the wrong place or not, if it is, then make it right with tweezers.

7. The way of making the balls fixed is using the Reballing machine; it can heat the cheap medially. Up to now, we finished reballing.



7th、Maintenance

(1) Upper heater: (Pictured)

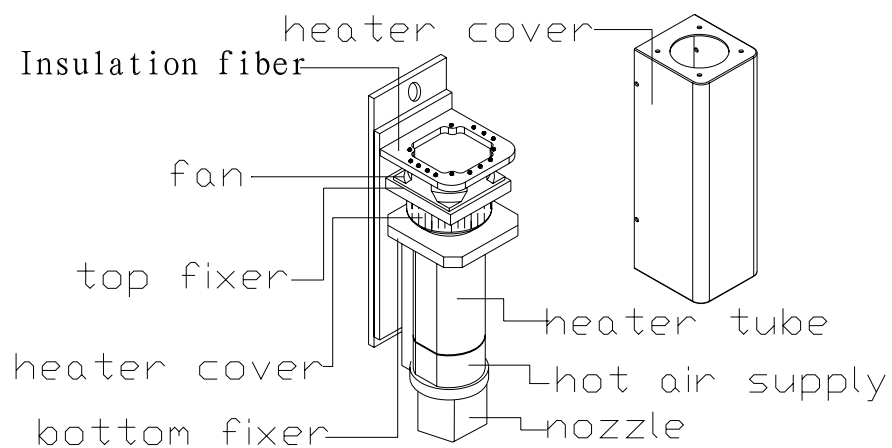

1. The replacement of fan:

Remove the heater cover, and remove the insulation fiber block, then you can replace the fan.

2. The replacement of heating wire

Remove the heater cover 、 the insulation fiber block and fan, remove the upper fixed block, then

take out the hot wire. Then it can be replaced.

(二) Bottom heater (as pictured)

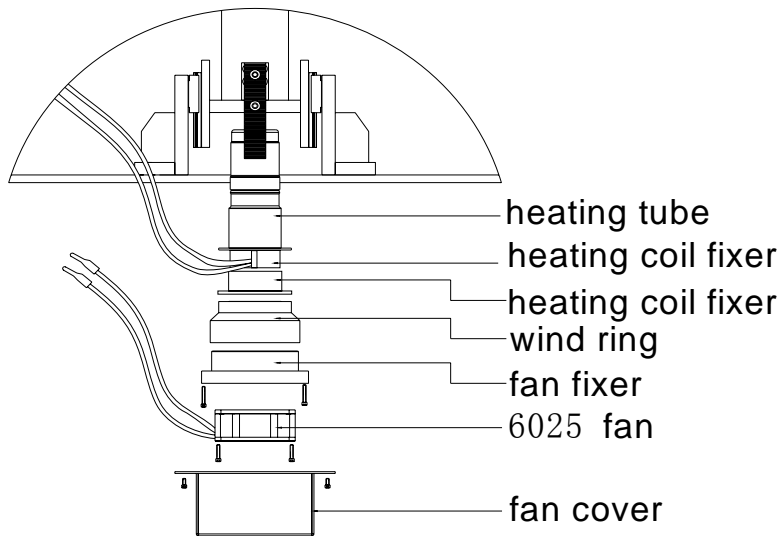

The lower (second temperature zone) heating wire replacement (as pictured)

- 1、 remove the fixed screw, take out the fan cover;
- 2、 remove the 6025 fan;
- 3、 remove the fan fixer;
- 4、 remove the wind ring;
- 5、 remove the heating coil.

(3) The bottom heating panel (pictured)

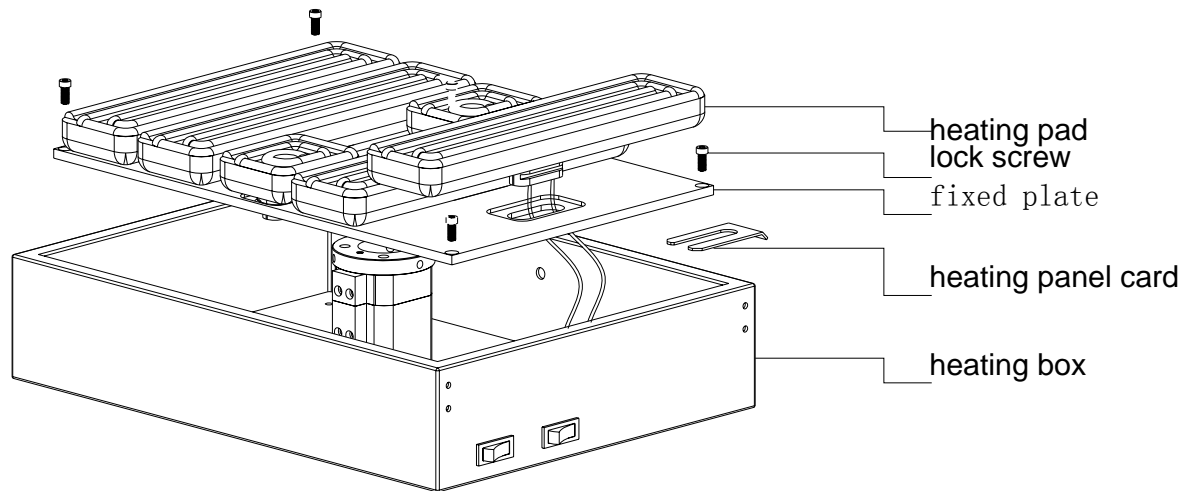

Replacement of heating plate:

1. Demolition of locking screws (4), remove the heating plate and the assembly of the fixed plate, placed on the table which is covered with a sponge (with heating plate surface facing down).
2. Removed the fixed heating plate card, you can break down the fixed plate and heating plate assembly, remove the heating plate then it can be replaced.

8th、 Safety Precautions



The power supply of ZM-R6820G is AC220V, the temperature can arrive to 400°C. If you do not operate inappropriately, it will cause damaging to the machine or even to the operator. So you must strictly abide by the following matters:

1. Don't blow to the rework station directly when it is working, or there will be a negative difference from the surface of the heating board, thus some parts will be burnt out.
2. After it is started, the high temperature area should not touch any objects, or it will lead to a fire or explosion. The PCB and other parts should be put on the PCB bracket.
3. No vibration. Handle it gently.
4. Don't touch the heaters with your hands when it is working, or you will get hurt.
5. Don't use combustible spray, liquefied and flammable gas near the rework station after it

is started.

6. Don't try to re-equip the machine, or there may be a fire or an electric shock.
7. There are high-pressure parts in the circuit box. Don't disassemble it.
8. If some metals fall in the rework station when it is working, turn off the power immediately. After it is cooled down, get the metal out, and clean the machine. If not, there may a smell when the machine starts working next time.
9. When the rework station's temperature rises abnormally or smokes, turn off the power and inform the service technicians to repair it. Turn off the power of the circuit box and the machine while moving the rework station. Hold the plug when we remove the wire or it will lead to a poor contact then the machine can't work very well.
10. Turn off the power when stop using it.
11. Don't put the rework station on the wires, or there may be a failure, a fire, or an electric shock.
12. Before you use the machine, you must read the instructions attentively.

Note: when the machine works, it will produce some smell. So ensure the comfortable, healthy and safe operation environment, please keep the air in circulation.

Under the following case, if it causes any damage, it will not in our guarantee;

- 1) Do not operate according to the condition of the environment and methods of operation that the manual book required;
- 2) The reason out of our product;
- 3) Not the transformation and maintenance of our company;
- 4) Do not operate accordance with the way of use that our company's products required;
- 5) The case that the temporal level of scientific and technological of our company was impossible to predict;
- 6) Natural disasters or man-made destruction and such non-responsibility of the Company premises, it will not in guarantee.

Normal BGA welding and disordering parameters (for reference)

The temperature curve of lead welding

41*41 the temperature setting of the BGA welding:

	preheating	insulation	heating	welding1	welding2	cooling
upper	160	185	210	235	240	225
time	30	30	35	40	20	15
bottom	160	185	210	235	240	225
time	30	30	35	40	20	15
slope	3. 0	3. 0	3. 0	3. 0	3. 0	3. 0
IR	180					

38*38 the temperature setting of the BGA welding:

	preheating	insulation	heating	welding1	welding2	cooling
upper	160	185	210	225	235	215
time	30	30	35	40	20	15
bottom	160	185	210	225	235	215
time	30	30	35	40	20	15
slope	3. 0	3. 0	3. 0	3. 0	3. 0	3. 0
IR	185					

31*31 the temperature setting of the BGA welding:

	preheating	insulation	heating	welding1	welding2	cooling
upper	160	180	200	215	225	215
time	30	30	35	40	20	15
bottom	160	180	200	215	225	215
time	30	30	35	40	20	15
slope	3. 0	3. 0	3. 0	3. 0	3. 0	3. 0
IR	180					

The upper is the reference temperature of the lead BGA.

The temperature curve of Lead-free welding

41*41 the temperature setting of the BGA welding

	preheating	insulation	heating	welding1	welding2	cooling
upper	165	190	225	245	255	240
time	30	30	35	55	25	15
bottom	165	190	225	245	255	240
time	30	30	35	55	25	15
slope	3. 0	3. 0	3. 0	3. 0	3. 0	3. 0
IR	210					

38*38 the temperature setting of the BGA welding:

	preheating	insulation	heating	welding1	welding2	cooling
upper	165	190	225	245	250	235
time	30	30	35	45	25	15
bottom	165	190	225	245	250	235
time	30	30	35	45	25	15
slope	3. 0	3. 0	3. 0	3. 0	3. 0	3. 0
IR	210					

31*31 the temperature setting of the BGA welding:

	preheating	insulation	heating	welding1	welding2	cooling
upper	165	190	220	240	245	235
time	30	30	35	40	20	15
bottom	165	190	220	240	245	235
time	30	30	35	40	20	15
slope	3. 0	3. 0	3. 0	3. 0	3. 0	3. 0
IR	210					

The upper is the reference temperature of the lead-free BGA.

Such as set 0 when the demolition of the cooling section of BGA.